

SoClean. —
DEVICE
DISINFECTOR

User Manual

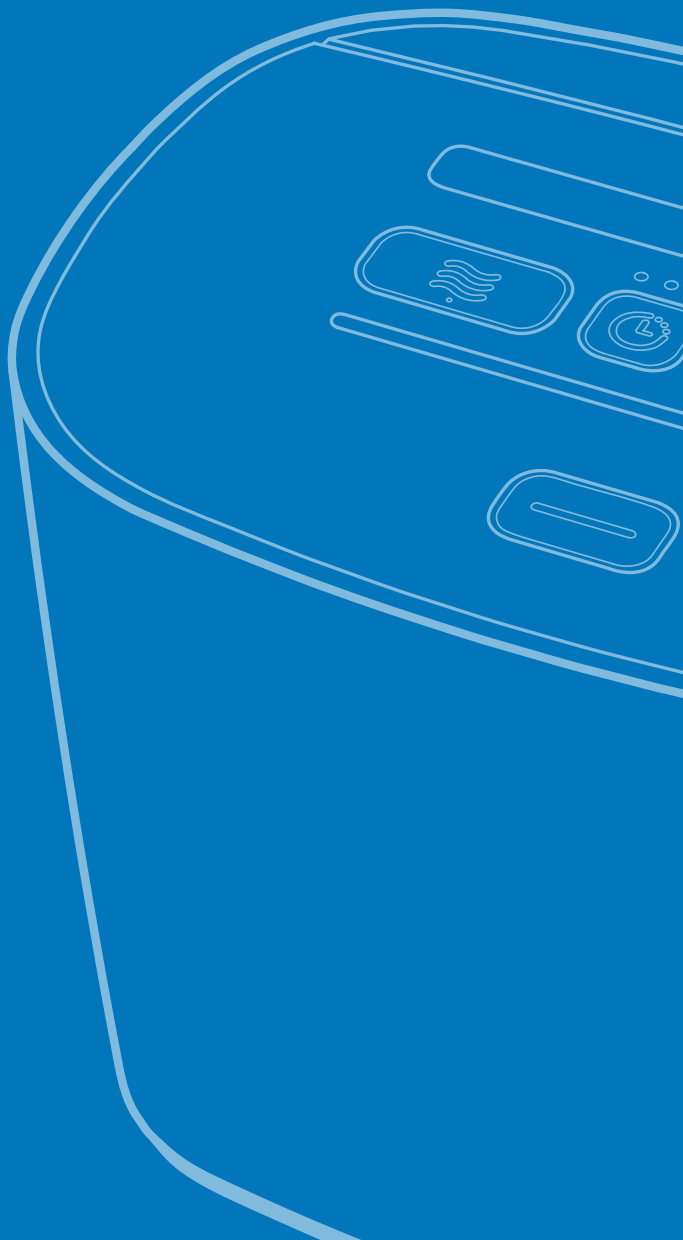

Model: SC1500

Thank you for purchasing SoClean Device Disinfector

The SoClean Device Disinfector kills germs on the surfaces of your common high-touch items when used in accordance with its labeled directions for use.*†

This manual contains the information you need to get your SoClean Device Disinfector up and running. Please read this entire manual carefully before using your SoClean Device Disinfector and keep it for future reference.

For questions regarding setup or operation, contact us by visiting **[SoClean.com/device-user-manual](https://www.soclean.com/device-user-manual)** or call **866-501-3705**.

*DO NOT use the SoClean Device Disinfector on and/or with any products regulated by the U.S. Food and Drug Administration (FDA), such as pharmaceuticals or medical devices, including prescription medical devices (e.g. CPAP parts), dental or oral devices (e.g. braces, retainers, or mouth guards).

†See [SoClean.com/device-user-manual](https://www.soclean.com/device-user-manual) for performance testing.

TABLE OF CONTENTS

Overview	04
Ozone Information	05
Warnings and Precautions	06
Warranty Information	07
Parts, Buttons & Icons	08
Setting up Your SoClean Device Disinfector	12
Using Your SoClean Device Disinfector	14
Maintenance	16
General Troubleshooting	18

OVERVIEW

SYMBOLS



Consult Manual



Do not use if package is damaged.



Not made with natural rubber latex

EPA Est. No. 96530-CHN-1



Serial Number



Waste Electrical and Electronic Equipment (WEEE). It is the responsibility of the end user to dispose of this equipment at a designated collection point.

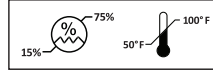

Operating Conditions



No Liquid in Chamber



Date of Manufacture



General Caution or Warning



Federal Communications Commission

DISPOSAL INFORMATION Safe Disposal of the device: Follow the local, state, and national governing ordinances and recycling instructions regarding disposal or recycling of the device and device components at the end of the expected service life.

SPECIFICATIONS

Operating Conditions

10°C to 38°C (50°F to 100°F)
15% to 75% humidity

Physical Characteristics

Dimensions: 7.875" x 7.25" x 8.875",
200 mm x 184 mm x 225 mm
Weight: 5.6 lbs, 2.5 kg
Cord Length: 4' 8", 1422.4 mm

Ozone Concentration

180ppm maximum from ozone generator

Electrical Characteristics

Use with power supply unit:
Model UES 18LCP-120150SPA
AC Adapter Output: DC 12V, 1.5A Max
Power Consumption: 18W Max

Storage and Transport Conditions

-20°C to +55°C (-4°F to 131°F)
15% to 95% non-condensing humidity

USB

USB output: 5V, 1A

OZONE INFORMATION

Ozone is a gaseous disinfectant that breaks down to oxygen after it is generated. The SoClean Device Disinfector has a Filter inside the Chamber to convert ozone back to oxygen and is designed to contain ozone within the system, contacting the items only, not the user, during the Cycle.

The smell of ozone is detectable at low concentrations by some people and you may smell ozone briefly during the Cycle. The scent of ozone has the characteristic of a sweet chlorine-like smell.

 **WARNING:** Discontinue use if strong ozone odor is detected or, in rare cases, if those with respiratory sensitivities experience irritation.

FCC NOTICE PART 15:

This device complies with part 15 of the FCC Rules. Operation is subject to the following two conditions: (1) This device may not cause harmful interference, and (2) this device must accept any interference received, including interference that may cause undesired operation.

NOTE: This equipment has been tested and found to comply with the limits for a Class B digital device, pursuant to part 15 of the FCC Rules. These limits are designed to provide reasonable protection against harmful interference in a residential installation. This equipment generates, uses and can radiate radio frequency energy and, if not installed and used in accordance with the instructions, may cause harmful interference to radio communications. However, there is no guarantee that interference will not occur in a particular installation. If this equipment does cause harmful interference to radio or television reception, which can be determined by turning the equipment off and on, the user is encouraged to try to correct the interference by one or more of the following measures:

- Reorient or relocate the receiving antenna.
- Increase the separation between the equipment and receiver.
- Connect the equipment into an outlet on a circuit different from that to which the receiver is connected.
- Consult SoClean Customer Care for help.

 **FCC Caution:** Changes or modifications not expressly approved by the party responsible for compliance could void the user's authority to operate the equipment.

 **FCC Caution:** This equipment complies with FCC/IC RSS-102 radiation exposure limits set forth for an uncontrolled environment. To maintain compliance with the FCC and IC RF Exposure guidelines, place the unit at least 20 cm away from nearby persons.

Warnings and Precautions

- ⚠ **WARNING:** Discontinue use if strong ozone odor is detected or, in rare cases, if those with respiratory sensitivities experience irritation.
 - ⚠ **CAUTION:** Do not submerge the SoClean Device Disinfector in water or use chemical cleaners on or in your SoClean Device Disinfector. Keep away from water sources including rain, bathtubs, sinks, and pools.
 - ⚠ **WARNING:** Do not place any living thing inside the Device Chamber.
 - ⚠ **WARNING:** Do not place any flammable or ignitable items on top of the SoClean Device Disinfector. Do not use in explosive air environments, near gas vapors, or other flammables, etc.
 - ⚠ **CAUTION:** Ensure that the SoClean Device Disinfector Lid Gasket is not damaged by inspecting for visible cracks before operating a Cycle.
 - ⚠ **WARNING:** Do not disassemble the SoClean Device Disinfector.
 - ⚠ **WARNING:** The appliance is only to be used with the power supply unit provided with the appliance.
 - ⚠ **WARNING:** This appliance is intended to be household and indoor used only.
 - ⚠ **CAUTION:** Do not clean your items with fragrant soap prior to device use.
 - ⚠ **CAUTION:** If the SoClean Device Disinfector has been dropped or visibly damaged or if cracks in the enclosure are noticed, stop usage and contact SoClean.
 - ⚠ **CAUTION:** In the event of loss of power, rerun the Cycle.
- NOTE TO USERS:** Any serious incident that has occurred in relation to the device should be reported to SoClean.
- ⚠ This appliance can be used by children aged from 8 years and above and persons with reduced physical, sensory or mental capabilities or lack of experience and knowledge if they have been given supervision or instruction concerning use of the appliance in a safe way and understand the hazards involved. Children shall not play with the appliance. Cleaning and user maintenance shall not be made by children without supervision.
 - ⚠ Prior to cleaning or other maintenance, the appliance must be disconnected from the supply mains.

Warranty Information

WARRANTY FOR SOCLEAN DEVICE DISINFECTOR

SoClean Inc. warrants this product under this warranty for a two (2) year limited warranty for defects in manufacture or workmanship.

For all warranty issues, a Return Authorization Number and Proof of Purchase is required. Please contact SoClean at info@soclean.com or 866-501-3705 for a Return Authorization Number. CODs are not accepted. Shipping fees are non-refundable.

Products repaired or replaced under this warranty will not incur reshipping charges. Under this warranty, the sole remedy shall be repair or replacement at SoClean's discretion.

This warranty does not cover product failures due to misuse, abuse, improper maintenance, normal wear and tear, typical required periodic replacement products, or circumstances beyond the control of SoClean.

IMPORTANT: Please purchase your Filter from SoClean to ensure authenticity. For purchases from an online marketplace such as Amazon®, please check “sold by SoClean” before making your purchase. Your SoClean Device Disinfector has been designed to only work with genuine SoClean Device Disinfector Filters. You will not be able to operate your SoClean system with an inauthentic SoClean Device Disinfector Filter. Warranties will be voided if the product is used with an inauthentic Filter and not replaced in accordance with usage instructions.

LIMITATION DAMAGES: SOCLEAN SHALL NOT BE LIABLE FOR ANY INCIDENTAL OR CONSEQUENTIAL DAMAGES FOR BREACH OF ANY EXPRESS OR IMPLIED WARRANTY ON THIS PRODUCT. NO LIABILITY ARISING FROM ITS USE, HOWEVER, CAN BE ACCEPTED BY THE COMPANY, WHO RESERVES THE RIGHT, WITHOUT PRIOR NOTICE, TO ALTER THE SPECIFICATIONS, CONSTRUCTION, OR CONTENT OF ITS EQUIPMENT AT THE COMPANY'S OWN DISCRETION.

For further questions or concerns, visit our website: soclean.com/device-user-manual

Call: 866-501-3705

PARTS, BUTTONS & ICONS

LID GASKET

Seals the Lid in order to contain ozone within the Chamber.

⚠ CAUTION: Ensure that the SoClean Device Disinfector Lid Gasket is not damaged by inspecting for visible cracks before operating a Cycle.

LID LATCH

Keeps the Lid of the device closed securely during the Cycle.

CHAMBER

Place your items inside the Chamber during a Cycle.

Be careful not to overfill or force Lid closed.

CONTROL PANEL

Houses all the buttons and icons for operating your SoClean Device Disinfector.

LID

Opens for access to the Chamber.

NOTE: The SoClean Device Disinfector Lid will not open during a Cycle until the Cycle Complete Icon illuminates green.

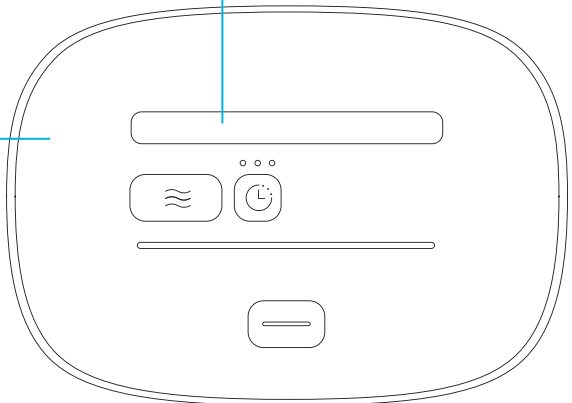
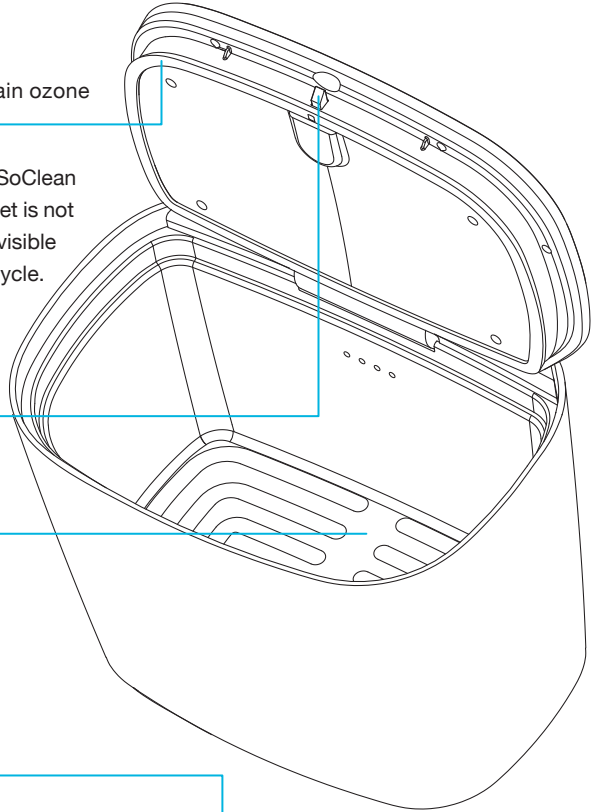

FILTER

Converts ozone in the Chamber into oxygen. Your device will remind you when the Filter needs to be replaced.

FILTER DOOR

Your Filter goes in here. The device will not operate a Cycle if the Door is open, or if the Filter is inauthentic or missing.

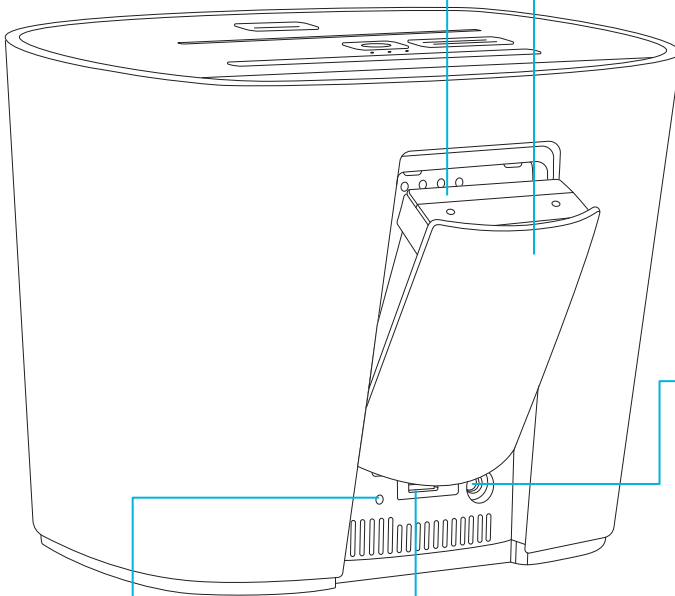

POWER INPUT

The Power Supply provided plugs in here.

AIR INLET

Air enters the device from this small hole and is converted into ozone during the Cycle.

PHONE CHARGING PORT

There is a USB port on the back for convenient charging of another device. Do not attempt to charge a device that is in the Chamber.

⚠ WARNING: Do not disassemble the SoClean Device Disinfector.

PARTS, BUTTONS & ICONS

CYCLE START

Initiates the Cycle with a single push.

CYCLE LENGTH

Used to set a 5, 10 or 20 minute Cycle Length.

The default Cycle Length is set to 20 minutes. You can select a length by pushing once for 5 minutes, twice for 10 minutes and three times for 20 minutes.

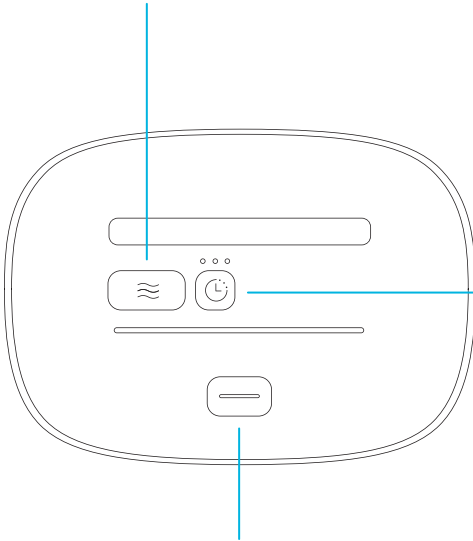

LID OPEN

Opens the Lid when the device is powered. This button can also be used to cancel an active Cycle by pushing and holding for 5 seconds.

NOTE: If you cancel a Cycle, the Lid cannot be opened until Cycle Complete Icon illuminates green.

NOTE: There is no power button. The device is powered and “on” when it is plugged in.

⚠ CAUTION: In the event of loss of power, rerun the Cycle.

**SYSTEM****Solid Red**

Indicates when your device has detected an issue that prevents it from operating a Cycle. Contact customer care for assistance.

Flashing Red



Indicates that the Lid cannot be opened because a Cycle is in process. See step 4 on page 15 for Canceling a Cycle.

**CYCLE COMPLETE****Solid Green**

Indicates that a Cycle is complete.

**5, 10 OR 20 MINUTE
CYCLE LENGTH**
Solid Blue

Indicates if a Cycle Length has been programmed.

1 push		5 min.
2 pushes		10 min.
3 pushes		20 min.

**FILTER ISSUE****Flashing Amber**

Indicates that it is time to order a new Filter.

NOTE: You can still use your device during this time.

Solid Amber

Indicates that your Filter has expired and will need to be replaced. **You will not be able to operate a Cycle.**

**FILTER DOOR ISSUE****Solid Amber**

Indicates that the Filter Door is not completely closed. Check your Filter Door and open/close it securely.

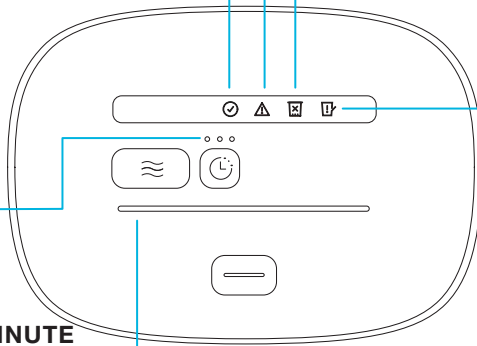
**CYCLE PROGRESS BAR****Progressive Blue**

Gradually turns **blue** from the left to the right as an indication of the progress of a Cycle.

Solid Red

Indicates that an active Cycle has been interrupted (example: temporary loss of power).

NOTE: During this time, your device is pumping air through the system to remove ozone.

SETTING UP YOUR SOCLEAN DEVICE DISINFECTOR

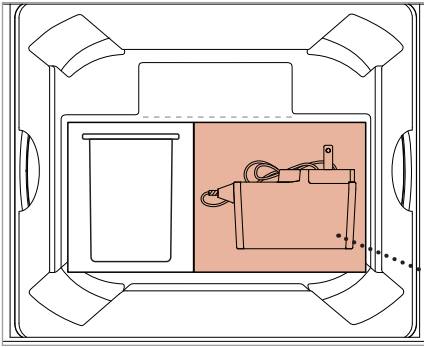

- 1** Plug one end of the **Power Adapter** cord into the back of the device and the other end into AC wall outlet.

**Power
Adapter**

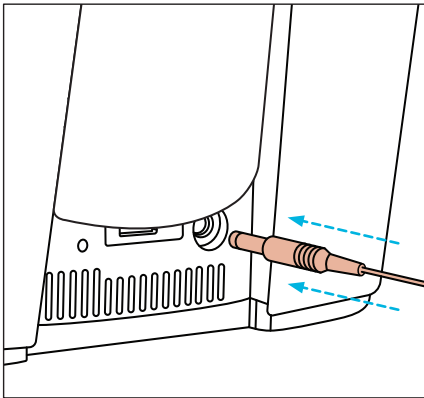

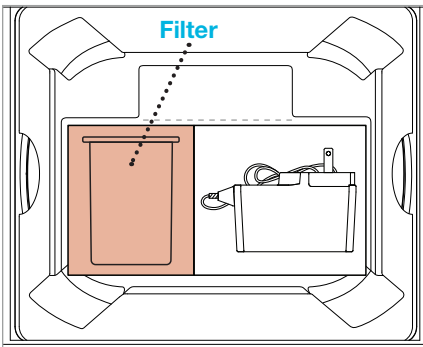

- 2** Unpack and install the **Filter** into the back of the device. Ensure that the blue rubber gasket on the **Filter** is facing the **Chamber**.

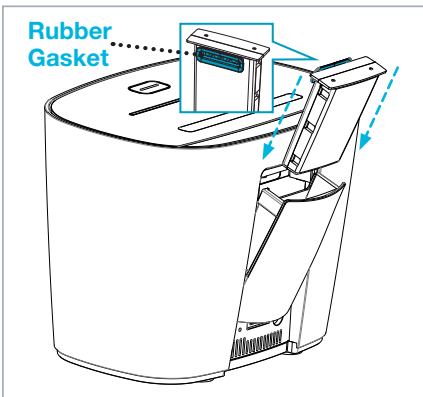

USING YOUR SOCLEAN DEVICE DISINFECTOR

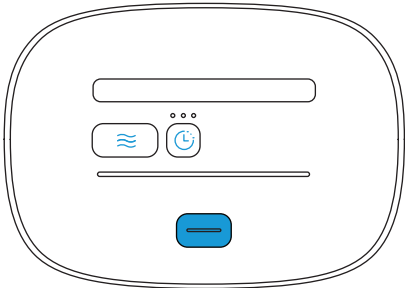

STEP 1

Open the Lid by pressing the Lid Open button.

NOTE: The SoClean Device Disinfector Lid will not open during a Cycle until the Cycle Complete Icon illuminates green.

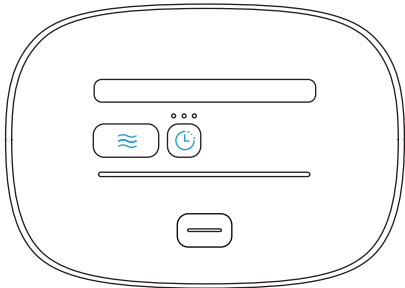

STEP 2

Organize your items inside the device Chamber and close the Lid.

Do not to stack your items in the Chamber. The ozone needs room to flow around the items. Do not block the ozone port.

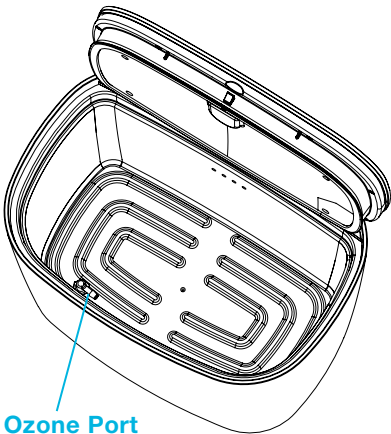

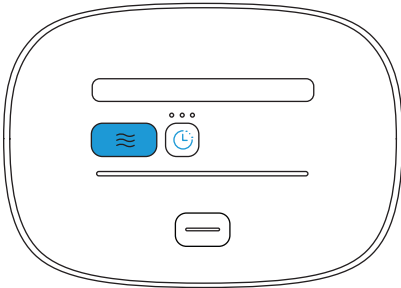

STEP 3

Run a Cycle by first selecting your desired Cycle Length then pushing the Cycle Start button. The default Cycle Length is set to 20 minutes.

⚠ WARNING: Discontinue use if strong ozone odor is detected or, in rare cases, if those with respiratory sensitivities experience irritation.

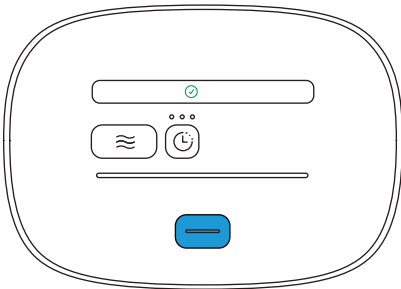

STEP 4

When the Cycle Complete icon lights up green you can now push the Lid Open Button and remove your items.

NOTE: You can cancel a Cycle at any time. Simply press and hold the Lid Open button for 5 seconds. The cancellation will not happen immediately. The system needs time to purge the ozone from the Chamber.

During this time, the System icon will flash red indicating the Lid is locked and the Cycle Start button will illuminate blue. The Progress Bar on the Control Panel will flash blue while the cycle cancellation is in progress.

The Cycle Complete Icon will light up green when you can open the Lid to remove your items.

Maintenance

CLEANING YOUR DEVICE

To clean, wipe the interior and exterior of your device with a slightly damp cloth. **Do not submerge the device in liquid or use chemical cleaners. Do not put water inside the device Chamber.**

⚠️ **CAUTION:** Do not submerge the SoClean Device Disinfector in water or use chemical cleaners on or in your SoClean Device Disinfector. Keep away from water sources including rain, bathtubs, sinks, and pools.

WASHING YOUR ITEMS

To pre-clean dirt or oil, use fragrance-free wipes or soap on your high-touch items before dropping them into the SoClean Device Disinfector.

⚠️ **CAUTION:** Do not clean your items with fragrant soap prior to device use.

VISIBLE CRACKS OR DAMAGE

⚠️ **CAUTION:** If the SoClean Device Disinfector has been dropped or visibly damaged or if cracks in the enclosure are noticed, stop usage and contact SoClean.

REPLACING THE FILTER

The advanced technology in our Filter quickly converts the ozone, into fresh oxygen as it exhausts from the unit. No need to mark your calendar, your device will remind you! Filter must be replaced approximately every 6 months with one Cycle run per day. The Filter Issue icon will flash **amber** to remind you to change your Filter.

The device will no longer operate a Cycle if the Filter replacement warning expires and turns solid amber before the Filter is replaced.

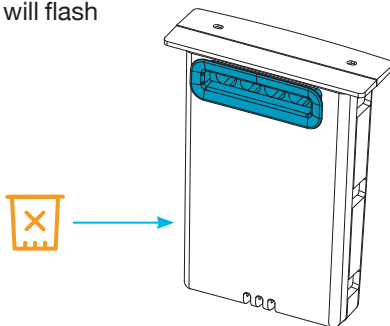

REORDERING PARTS OR ACCESSORIES

To reorder supplies, contact your authorized reseller or visit SoClean.com/device.

IMPORTANT: For extended product life, use only authentic parts. Please purchase your Filters from SoClean to ensure authenticity. For purchases from an online marketplace such as Amazon® or eBay® please check “sold by” SoClean before making your purchase. Authentic SoClean Filters contain unique technology required for use of the SoClean Device Disinfector. The manufacturer is not responsible for device malfunction or accidents caused by the use of inauthentic parts or accessories. Please contact SoClean immediately if you have had any issues with your Filter.

Your SoClean Device Disinfector has been designed to only work with authentic Filters. You will not be able to operate your SoClean Device Disinfector with an inauthentic Filter.

Amazon® is a registered trademark owned by Amazon Technologies, Inc. eBay® is a registered trademark owned by eBay, Inc. SoClean® is a registered trademark owned by SoClean, Inc.

Part name	SKU	Description
Filter	PN1507	The Filter converts ozone in the Chamber to oxygen after the Cycle has run. The Filter needs to be replaced approximately every 6 months with one Cycle run per day. The device reminds you when the Filter needs replacement.
AC Power Adapter	PN1422	Used to power your SoClean Device Disinfector.

General Troubleshooting

PROBLEM

YOU SEE

POSSIBLE CAUSES

Device will operate a Cycle but needs a replacement part soon



This icon is flashing **amber** on the Control Panel

Time to order new filter.

Your device will not operate a Cycle



This icon is solid **amber** on the Control Panel

The Filter door may be open.



This icon is solid **amber** on the Control Panel

The Filter is expired.



This icon is solid **red** on the Control Panel

There may be an internal device issue.

None of the lights illuminate, even when I push buttons

The device may not be powered.

SOLUTIONS

Order replacement Filter.

Open and securely close the Filter door.

Replace with a new Filter.

**Unplug your device from its power source and plug it back in.
If the issue persists, contact SoClean customer service.**

**Check that the AC power cord is plugged-in correctly
into the back of the device and the AC wall outlet.**

PROBLEM **YOU SEE**

Your device will not operate a Cycle

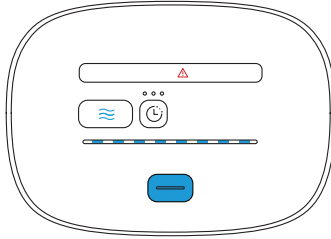

Progress bar is flashing **blue**.

Lid does not open when the Lid Open button is pushed

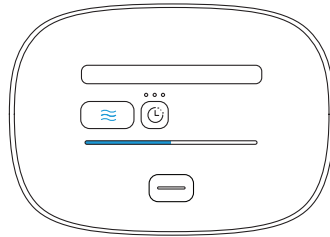

These icons are illuminated **blue** on the Control Panel.

The “!” icon will flash after the Lid Open button is pushed.

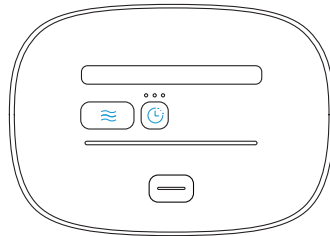

I hear a click and the buttons light up **blue** but the Lid doesn't open.

Your device is making a noise like it's operating but there are several red indicators on the control panel

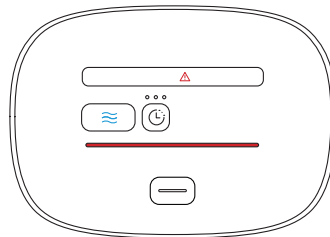

These icons are illuminated on the Control Panel.

POSSIBLE CAUSES

SOLUTIONS

Indicates the Cycle has been canceled.

The Progress Bar on the Control Panel will flash **blue** until the cycle cancellation progress is complete.

The Cycle is running.

The Lid is locked during a Cycle. To cancel the cycle, press the Lid Open button for approximately 5 seconds. The cancellation will not happen immediately. The system needs time to purge the ozone from the Chamber. The Cycle Complete icon will illuminate green signaling that the Lid can now be opened.

The Lid may be stuck.

Be sure to release the button once you hear the click.

Your device was operating a Cycle and one of the following occurred:

- Power to the device was momentarily lost
- Lid was forced opened
- Internal device Issue

Your device is pumping air through the system to remove ozone and allow you to access your items. Allow this Cycle to complete. You can then either remove your items for use or start a new Cycle.

PROBLEM YOU SEE POSSIBLE CAUSES

Strong scent of ozone during Cycle

Your device appears to operate normally.

There may be physical damage to your device.

My item is discoloring or getting sticky

Your device appears to operate normally.

Material in your item may be incompatible with ozone.

SOLUTIONS

Disconnect the power, step away from the device and contact SoClean.

Discontinue use and contact SoClean customer service.

Manufactured for:
SoClean Inc.
12 Vose Farm Road
Peterborough, NH U.S.A. 03458
866-501-3705

SoClean.com/patents
EPA Est. No. 96530-CHN-1

SoClean® DEVICE
DISINFECTOR